

"Semur & Co" LLC

The company "Semur & Co" was founded in 2003. The main sphere of its activities is the production of different types of wire meshes, corrugated sheets and metal tiles, as well as all the accessories from hot dipped galvanized steel and pre-painted galvanized steel. The imported raw material is one of the best in the International market. Owing to professionalism of the engineers the company "Semur & Co" guarantees to the clients the best solution of the roofing problems. High quality of the materials and the services are the best pledge of success of the company.

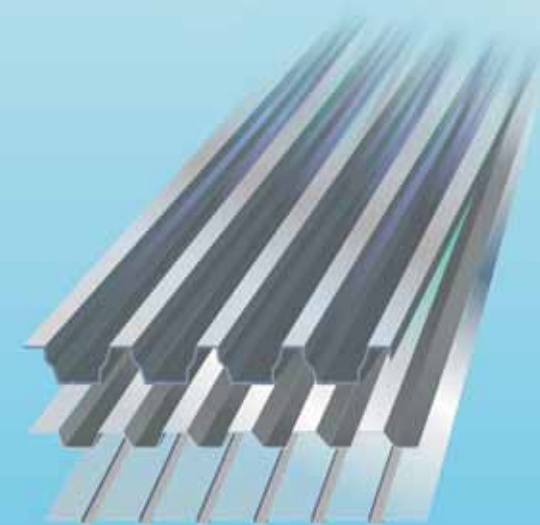

Tel. (010) 54 26 40; 52 24 90

(010) 52 26 40; 58 26 41

Factory tel (091) 46 11 61

(010) 20 06 00; 20 04 00

(0224) 6 11 61; (0224) 6 11 71

Fax: (010) 52 26 20

Republic of Armenia

1 Baghramyan str.

Yerevanyan highway Yeghvard

E-mail: semur_ko@rambler.ru

<http://www.semur.am>

The best
sheet-lead

SP 10

width 1160 mm
effective cover width 1100 mm
thickness 0.5 mm
max. length 15 m



KP 18

width 1200 mm
effective cover width 1150 mm
thickness 0.5-0.7 mm
max. length 15 m



KP 21

width 1080 mm
effective cover width 1000 mm
thickness 0.3-0.7 mm
max. length 15 m

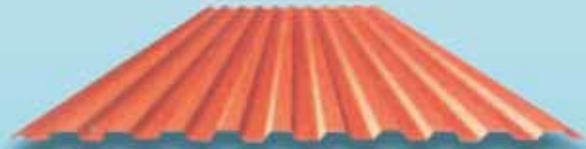

KP 25

width 1130 mm
effective cover width 1015 mm
thickness 0.35-0.7 mm
max. length 15 m



KP 35

width 1100 mm
effective cover width 1000 mm
thickness 0.5-0.9 mm
max. length 15 m



KP 60

width 900 mm
effective cover width 850 mm
thickness 0.6-1.0 mm
max. length 15 m



TECHNOLOGY OF OUR PRODUCTION

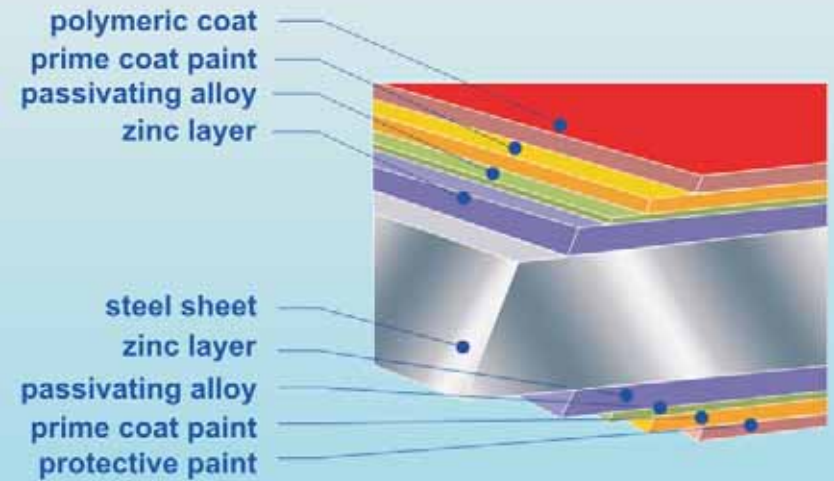



CLASSIC

width	1180 mm
effective cover width	1100 mm
thickness	0.5 mm
max. length	9.45 m



MONTEREY

width	1170 mm
effective cover width	1035 mm
thickness	0.5 mm
max. length	9.45 m



CASCADE

width	1140 mm
effective cover width	1050 mm
thickness	0.5 mm
max. length	9.45 m



BANGA

width	1170 mm
effective cover width	1100 mm
thickness	0.5 mm
max. length	9.45 m

1. Ridge N1 L=2.5 m
2. Ridge N2 L=2.5 m
3. Ridge N3 L=2.5 m
4. Ridge N4 L=1.25 m
5. Gutter semicircular L=1.25 m
6. Gutter rectangular L=2.5 m
7. Finnish gutter L=3.5 m
8. Round water-pipe L=1.25 m
9. Rectangular water-pipe L=1.25 m
10. Arm of the rectangular pipe
11. Arm of the round pipe
12. Angle of the rectangular gutter (exterior and interior)
13. Angle of the Finnish gutter (exterior and interior)
14. Snow barrier L=1.25 m
16. Finnish snow barrier L=1.5 m, L=2.0 m
17. Funnel (with round and rectangular water-pipe)



Bucket
(zinc coated and pre-painted)



Screws and nails
(for wood and metal)

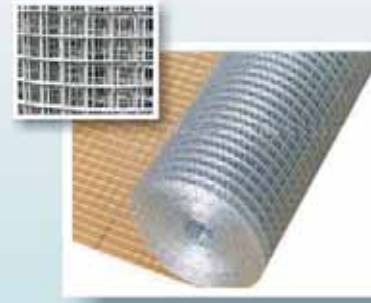

Welded wire meshes
Hole dimension - 10x10, 20x20
Raw material - galvanized wire
Thickness - 0.6-1.7 mm
Width - 1.2 m
Max. length - 25 m

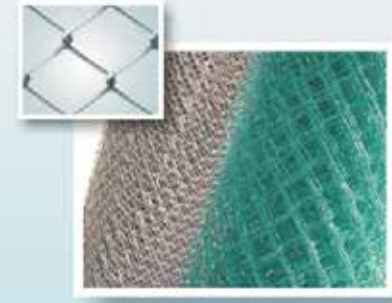

Fence link chain
Hole diameter - 30x30, 40x40, 50x50, 60x60, 70x70
Raw material - galvanized wire PVC and steel
Thickness - 2.0-2.5 mm
Width - 1.5-3.0 m
Max. length - 10 m



Hook - 200, 300
Profile: F - 47, G - 60

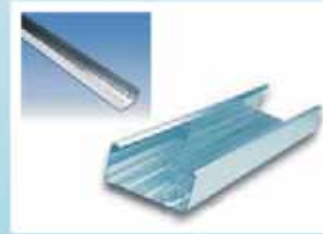

Profiles for gypsum carton
G - 60, length - 3.0 m
U-50, length - 4.0 m



Expanded metal mesh
(with different holes)
Raw material - HDG and CR
Thickness - 0.5 mm
Width - 1.0 m
Max. length - 9.0 m



Hexagonal wire net
Hole diameter - 9x9 mm,
Raw material - galvanized wire
Thickness - 0.6-1.4 mm
Width - 1.5 mm
Max. length - 20 m



Profile
Length - 3.0 m

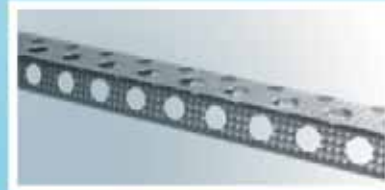

Profile
Length - 2.7 m



Waterproof and vapour permeable roofing membrane

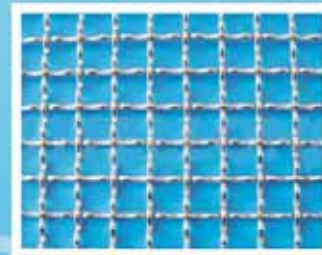

Crimped wire mesh
1000 mm x 2000 mm
Hole diameter 20 mm - 200 mm
Thickness 3.0 mm - 5.0 mm



Barbed wire mesh
Thickness 2.8 mm